

KW3A型微動開關系列 Micro switch series

◆ 安全可靠的基本開關 Safe, reliable basic switch

- 外形美觀，結構緊湊。具有微小觸點間隙，快速動作、高靈敏和微小動作行程的特點。
Nice appearance, tight configuration. Characteristic: small contact clearance, quick action, high sensitivity and small operating travel.
- 長壽命，高可靠。
Long life, high reliability.
- 接線端子種類齊全
A variety of contact terminals
- 動作力範圍寬
A variety of models with low operating force to high operating force are available
- 多種溫度等級
A variety of temperature degree
- 配備各種形式動臂
A variety
- 採用熱固性或熱塑性塑料
Adopt thermosetting plastic or thermoplastic
- 廣泛應用於各種家用電器、電子設備、自動化設備、通訊設備、汽車電子、儀器儀表、電動工具等領域。
Widely used in home appliance, electronic equipment, automatic machine, communication equipment, car electron, apparatus and instrument, electric motion tool etc.



◆ 技術特性 Specifications

項目 Item		特性值 Value
工作速度 Operating speed		0.1mm ~ 1m/s (與驅動方式有關)(Related with actuator forms)
工作頻率 Operating Frequency		機械 60次/min; 電氣 25次/min Mechanical 60 cycles/min; Electrical 25cycles/min
絕緣電阻 Insulation resistance		≥ 100MΩ (500VDC)
接觸電阻 Contact resistance		≤ 30mΩ (初始值)(Initial value)
耐電壓 Test voltage	同極不相接端子間 Between terminals of the same polarity	AC1000V, 50/60Hz, 1min
	帶電金屬零件與地(外殼)之間、接線端與不帶電金屬件之間 Between current-carrying metal parts and ground (case), and between each terminal and non-current-carrying metal parts.	AC3750V, 50/60Hz, 1min
抗振動 Vibration resistance		10 ~ 55Hz, 1.5mm 雙振幅 Double amplitude
抗衝擊 Shock resistance		破壞: 動作力 > 0.5N: 1000m/s ² (約100G)max 動作力 ≤ 0.5N: 400m/s ² (約40G)max 故障: 動作力 > 0.5N: 200m/s ² (約20G)max 動作力 ≤ 0.5N: 100m/s ² (約10G)max Destruction: OF > 0.5N: 1000m/s ² (approx. 100G)max OF ≤ 0.5N: 400m/s ² (approx. 40G)max Malfunction: OF > 0.5N: 200m/s ² (approx. 20G)max OF ≤ 0.5N: 100m/s ² (approx. 10G)max
壽命 Life expectancy		機械 ≥ 2,000,000次; Mechanical ≥ 2,000,000 cycles 電氣 ≥ 50,000次 Electrical ≥ 50,000cycles
質量 Weight		約6.2g(無動臂型) Approx. 6.2g(No lever)
安全認證 Safety approvals		UL、CUL、VDE、TUV、SEMKO、DEMKO、NEMKO、FIMKO、CE、EK、CQC

◆ 型號規格命名及含義 Model number legend and meanings

 KW3A □-□□□□□-□□□□- (□)
 1 2 3 4 5 6 7 8 9 10 11

1 溫度等級 Degree of temperature	無標記 No mark: T85,10T105 T:T125 H:T150 G:T200	5 外殼材質 Case material	無標記 No mark: 熱塑性 thermoplastic G: 熱固性 thermosetting
	2 額定值 Ratings	KW3A: 25:25(4)A250VAC 16:16(4)A250VAC/16A125VAC 10:10(3)A250VAC/10A125VAC 5 : 5(2)A250VAC/5A125VAC 1 : 1(0.3)A250VAC/1A125VAC KW3AT: 21:21(4)A250VAC 16:16(4)A250VAC/16A125VAC 10:10(3)A250VAC/10A125VAC 05:5(2)A250VAC/5A125VAC 01:1(0.3)A250VAC/1A125VAC KW3AH: 22:22A125VAC 10:10(3)A250VAC/10A125VAC 05:5(2)A250VAC/5A125VAC 01:1(0.3)A250VAC/1A125VAC KW3AG: 22:22A125VAC 10:10A125VAC 05:5A125VAC/0.1A30VDC,1A30VDC 01:1A125VAC/0.1A30VDC,1A30VDC	6 外形特徵 Outline characteristic
7 端子類型 Terminal types			A: 250 快接端子 Quick-connect terminal B: 187 快接端子 (厚0.8mm) 187 quick-connect terminal (thick 0.8mm) C: 187 快接端子 (厚0.5mm) 187 quick-connect terminal (thick 0.5mm) D: 焊接/187共用端子 Solder/187 common terminal E: 螺孔端子 Screw terminal F: 焊接端子 Solder terminal L: 左側面PCB端子 Left side PCB terminal R: 右側面PCB端子 Right side PCB terminal H: 250快接端子之二 250Quick terminal No.2 Y: 非標準端子 Not standard terminal
8 動作力(max) Operating force			015: 0.15N 025: 0.25N 050: 0.5N 100: 1N 150: 1.5N 200: 2N 300: 3N 400: 4N 注: 若是非標準動作力, 用此動作力上限值表示。 Note: if it is not standard operating force, indicate with the upper limit.
3 接觸形式 Circuit	Z: 轉換式 SPDT T: 常開(接通)式 SPST-NO D: 常閉(按斷)式 SPST-NC (見說明圖 See illustration)	9 按鈕規格 Plunger spec	無標記: 標準按鈕 No mark-standard plunger A: 短按鈕 Short plunger B: 中長按鈕 Middle plunger C: 長按鈕 Long plunger D: 平端按鈕 Flat plunger (見說明圖see illustration) 注: 若用本表中未列入的非標準按鈕, 則用此新增按鈕的規格代號(本公司確認)表示。 Note: If adopt other not standard plunger, then indicate with the new spec (confirmed by our company.)
			10 觸點間隙 Contact gap
4 驅動形式 Actuator forms	0:無動臂 No lever A1/1: 短動臂 Short lever A2/2: 長動臂 Long lever A3/3: 中動臂 Middle lever A4/4: 短滾輪臂 Short roller A5/5: 長滾輪臂 Long roller A6/6: 弧形動臂 Arc lever A□/□: 非標準動臂 Not standard lever 注: 1)A 表示動臂安裝在靠近按鈕位置, 無字母A表示動臂安裝在離按鈕較遠位置。 2)□表示非標準動臂的代號, 詳見動臂外形尺寸圖。 Note: 1) A indicate the lever near to the plunger, no A indicate the lever far away from the plunger. 2)□ Indicate not standard lever, details see outline dimension drawings.	11 附加規格編號和外殼顏色代號, 適用於: Additional specs numbers and case color code apply to:	1)當開關使用了非標準零件如非標準端子時; When used not standard parts such as not standard terminals; 2)當顧客有特殊動作特性值或其它要求時; When customer has particular operating value or other requirements; 3)當開關外殼顏色不是默認的灰色時, 如黑色用字母B表示。 When the case is not grey, for example, black shows as B. 附加規格編號用阿拉伯數字或拉丁字母表示, 字母代號位於數字之後。在沒有附加規格編號時, 該位置空缺。 Additional specs number shows by Arabic numerals or Latin, color code after the numbers. If there is no additional numbers, the place is vacant.

◆ 接觸形式說明圖 Circuit illustration

公共端類型 Common terminal types	轉換式 SPDT	常閉式 SPST-NC	常開式 SPST-NO
公共端在底部 Bottom common terminal			
公共端在側面 Side common terminal			

◆ 按鈕規格說明圖 Plunger spec illustration

按鈕標記 Mark on plunger	無標記 No mark	A	B	C	D
按鈕尺寸 Plunger dimension					

◆ 外形特徵說明圖 Outline characteristic illustration

基本形 Basic form	平端形 Flat form	公共端側面形 Side common terminal

◆ 接線端尺寸 Connect terminal dimensions

端子種類 Terminal types	快接端子#250 Quick-connect terminal #250	快接端子#187(t=0.8) Quick-connect terminal #187	快接端子#187(t=0.5) Quick-connect terminal #187	焊接/快接#187共用端子 Solder/Quick-connect terminal #187
下公共端 Bottom common terminal				
側公共端 Side common terminal				
端子尺寸 Terminal dimensions				

左側面PCB端子 Left side PCB terminal	右側面PCB端子 Right side PCB terminal	焊接端子 Solder terminal	螺孔端子 Screw terminal	快接端子#250之二 Quick connect terminal #250 No.2



◆ 內部構造圖 Internal configuration drawing

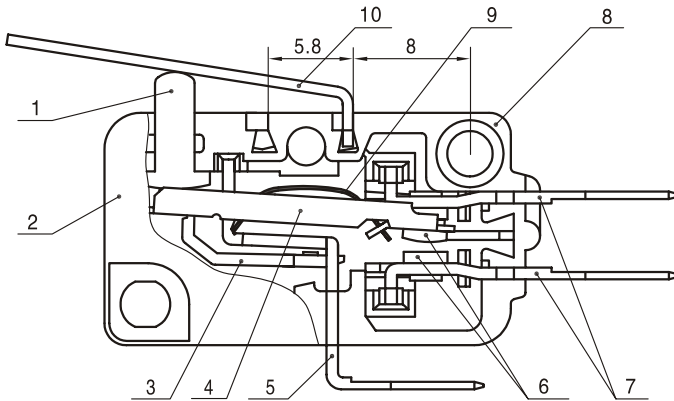

1 開關子(按鈕)	Plunger
2 蓋	Cover
3 杠杆	Lever
4 可動片	Moving piece
5 支架	Support
6 電觸點	Contact
7 端子	Terminal
8 基座	Case
9 簧片	Spring sheet
10 動臂(杠杆)	Moving arm(lever)

◆ 安裝孔尺寸 Mounting hole dimensions

	右側面PCB端子 Right side PCB terminal	左側面PCB端子 Left side PCB terminal

◆ 外形尺寸和動作特性 Dimensions and operating characteristics

KW3A-16Z0□-A100
KW3A-16Z0□-A150
KW3A-16Z0□-A200
KW3A-16Z0□-A300

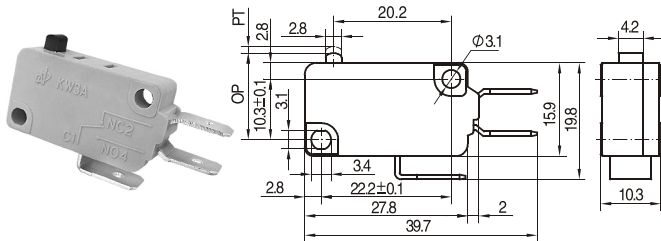

型號 Model	KW3A-16Z0□-A100	KW3A-16Z0□-A150	KW3A-16Z0□-A200	KW3A-16Z0□-A300
OF Max(N)	1.00	1.50	2.00	3.00
RF Min(N)	0.20	0.30	0.50	0.70
PT Max(mm)	1.4			
OT Min(mm)	1.0			
MD Max(mm)	0.4			
OP(mm)	14.9±0.4			

KW3A-16Z1□-A100
KW3A-16Z1□-A150
KW3A-16Z1□-A200
KW3A-16Z1□-A300

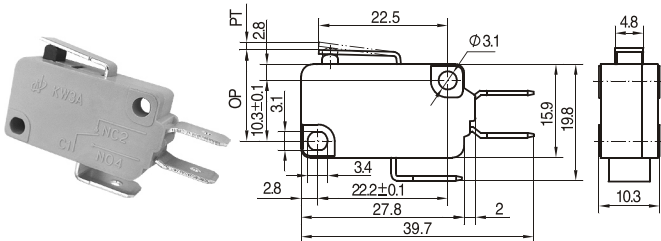

型號 Model	KW3A-16Z1□-A100	KW3A-16Z1□-A150	KW3A-16Z1□-A200	KW3A-16Z1□-A300
OF Max(N)	1.00	1.50	2.00	3.00
RF Min(N)	0.20	0.30	0.50	0.70
PT Max(mm)	1.4			
OT Min(mm)	1.0			
MD Max(mm)	0.5			
OP(mm)	15.8±0.5			



◆ 外形尺寸和動作特性 Dimensions and operating characteristics

KW3A-16Z3□-A100
 KW3A-16Z3□-A150
 KW3A-16Z3□-A200
 KW3A-16Z3□-A300

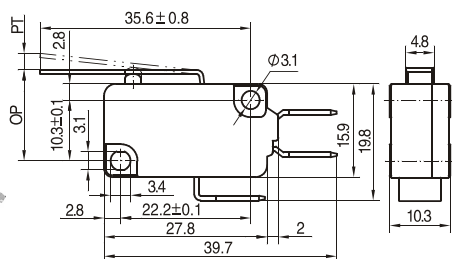

型號 Model	KW3A-16Z3□-A100	KW3A-16Z3□-A150	KW3A-16Z3□-A200	KW3A-16Z3□-A300
OF Max(N)	0.50	0.70	0.90	1.30
RF Min(N)	0.10	0.15	0.20	0.30
PT Max(mm)	4.0			
OT Min(mm)	2.0			
MD Max(mm)	1.0			
OP(mm)	16.3±1.2			

KW3A-16Z2□-A100
 KW3A-16Z2□-A150
 KW3A-16Z2□-A200
 KW3A-16Z2□-A300

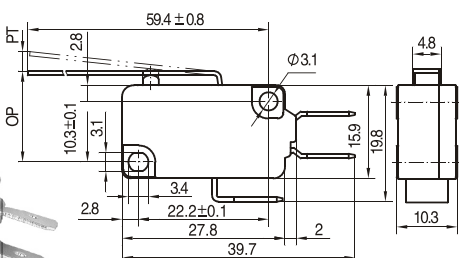

型號 Model	KW3A-16Z2□-A100	KW3A-16Z2□-A150	KW3A-16Z2□-A200	KW3A-16Z2□-A300
OF Max(N)	0.25	0.37	0.50	0.75
RF Min(N)	0.05	0.10	0.15	0.20
PT Max(mm)	8.0			
OT Min(mm)	4.0			
MD Max(mm)	2.0			
OP(mm)	17.2±2.5			

KW3A-16Z6□-A100
 KW3A-16Z6□-A150
 KW3A-16Z6□-A200
 KW3A-16Z6□-A300

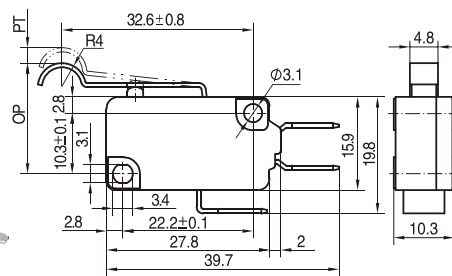

型號 Model	KW3A-16Z6□-A100	KW3A-16Z6□-A150	KW3A-16Z6□-A200	KW3A-16Z6□-A300
OF Max(N)	0.54	0.80	1.05	1.60
RF Min(N)	0.10	0.15	0.20	0.30
PT Max(mm)	4.0			
OT Min(mm)	2.0			
MD Max(mm)	1.0			
OP(mm)	19.5±1.2			

KW3A-16Z4□-A100
 KW3A-16Z4□-A150
 KW3A-16Z4□-A200
 KW3A-16Z4□-A300

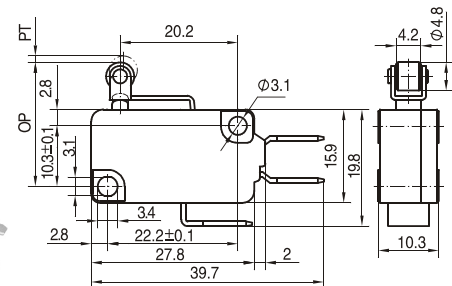

型號 Model	KW3A-16Z4□-A100	KW3A-16Z4□-A150	KW3A-16Z4□-A200	KW3A-16Z4□-A300
OF Max(N)	1.10	1.60	2.20	3.20
RF Min(N)	0.15	0.30	0.40	0.60
PT Max(mm)	1.4			
OT Min(mm)	1.0			
MD Max(mm)	0.4			
OP(mm)	21.4±0.6			

KW3A-16Z5□-A100
 KW3A-16Z5□-A150
 KW3A-16Z5□-A200
 KW3A-16Z5□-A300

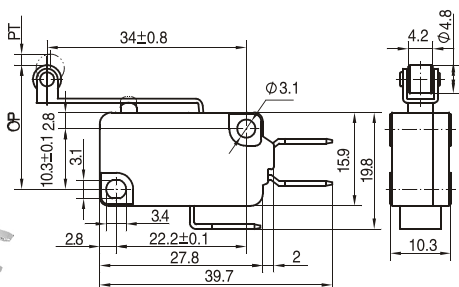

型號 Model	KW3A-16Z5□-A100	KW3A-16Z5□-A150	KW3A-16Z5□-A200	KW3A-16Z5□-A300
OF Max(N)	0.50	0.80	1.10	1.60
RF Min(N)	0.10	0.15	0.20	0.30
PT Max(mm)	4.0			
OT Min(mm)	2.0			
MD Max(mm)	1.0			
OP(mm)	21.4±1.2			

◆ 外形尺寸和動作特性 Dimensions and operating characteristics

KW3A-16Z0B-A100
KW3A-16Z0B-A150
KW3A-16Z0B-A200
KW3A-16Z0B-A300

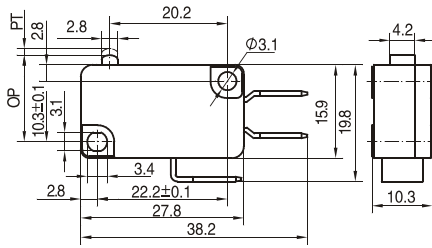
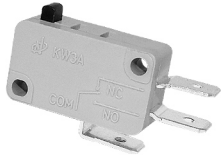

型號 Model	KW3A-16Z0B-A100	KW3A-16Z0B-A150	KW3A-16Z0B-A200	KW3A-16Z0B-A300
OF Max(N)	1.00	1.50	2.00	3.00
RF Min(N)	0.20	0.35	0.50	0.80
PT Max(mm)	1.2			
OT Min(mm)	1.0			
MD Max(mm)	0.4			
OP(mm)	14.9 ± 0.4			

KW3A-16Z0-C015
KW3A-16Z0-C025
KW3A-16Z0-C050

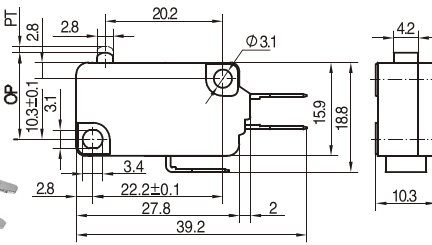

型號 Model	KW3A-16Z0-C015	KW3A-16Z0-C025	KW3A-16Z0-C050
OF Max(N)	0.15	0.25	0.50
RF Min(N)	0.04	0.07	0.15
PT Max(mm)	1.4		
OT Min(mm)	1.0		
MD Max(mm)	0.4		
OP(mm)	14.9 ± 0.4		

KW3A-16Z0C-A100
KW3A-16Z0C-A150
KW3A-16Z0C-A200
KW3A-16Z0C-A300

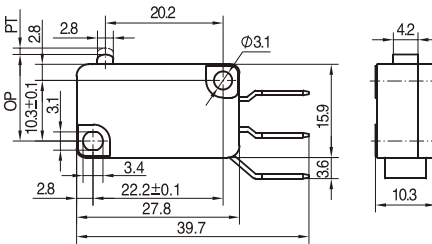
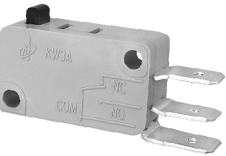

型號 Model	KW3A-16Z0C-A100	KW3A-16Z0C-A150	KW3A-16Z0C-A200	KW3A-16Z0C-A300
OF Max(N)	1.00	1.50	2.00	3.00
RF Min(N)	0.20	0.30	0.50	0.70
PT Max(mm)	1.4			
OT Min(mm)	1.0			
MD Max(mm)	0.4			
OP(mm)	14.9 ± 0.4			

KW3A-16ZS-B400Y-88

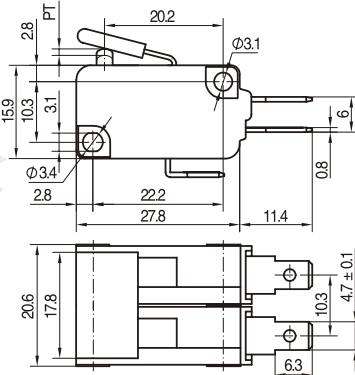
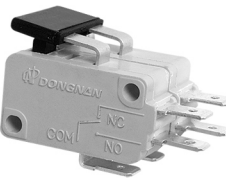

型號 Model	KW3A-16ZS-B400Y-88
OF (N)	2.80-4.00
PT max(mm)	1.4-2.0

注：動作力和動作行程均為開關子處未裝動臂時單個開關所測值。
Note: Operating force and operating travel are all measured by single switch when the button place does not installed the lever.

SCHEMATIC DIAGRAM

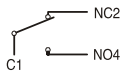

KW3A-16TA□9B-A080A

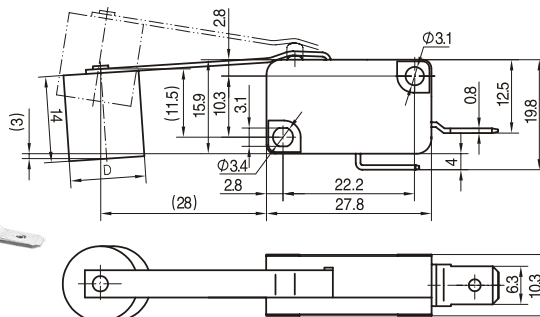
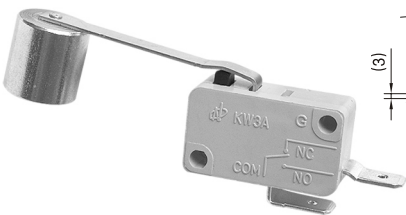

型號 Type	D	重錘材料 Counterpoise material
KW3A-16TAB9B-A080A	Φ12.7	HPb59-1
KW3A-16TAY9B-A080A	Φ13.4	Q235

SCHEMATIC DIAGRAM

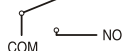

◆ 可供選擇的非標準動臂代號和外形特徵尺寸 Not standard levers for choose and outline characteristic dimensions

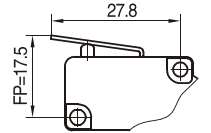
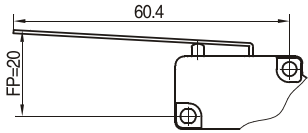
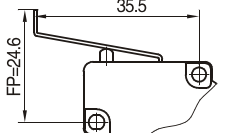
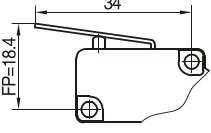
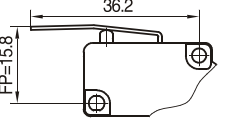
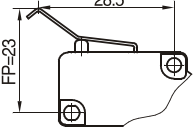
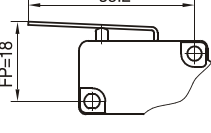
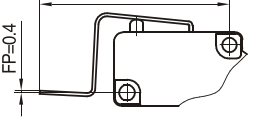
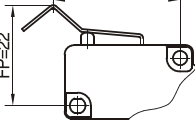
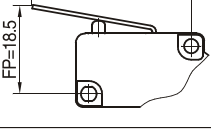
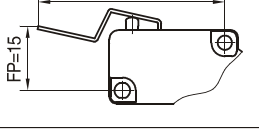
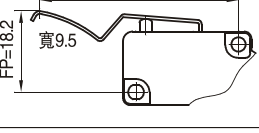
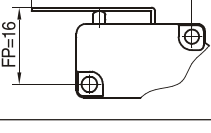
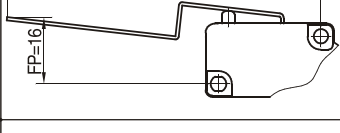
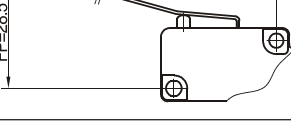
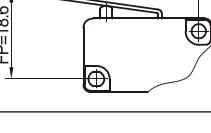
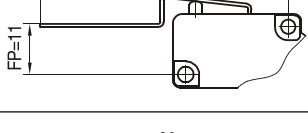
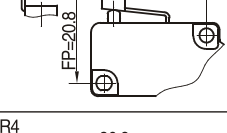
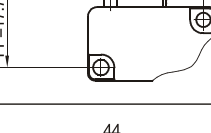
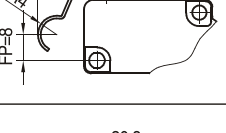
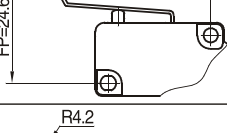
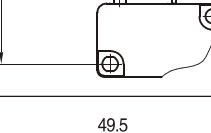
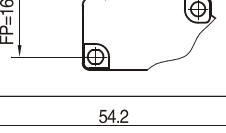
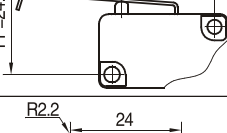
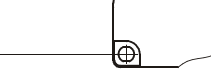
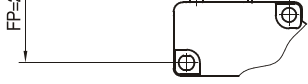
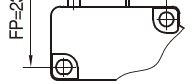
動臂代號 Lever code	外形特徵尺寸 Outline characteristic dimensions	動臂代號 Lever code	外形特徵尺寸 Outline characteristic dimensions	動臂代號 Lever code	外形特徵尺寸 Outline characteristic dimensions
Q2		P2		P5	
R		B3		U	
B4		E2		U3	
H		E3		V	
D		E4		X	
C		I1		Y	
N1		J2		W	
T		O1		M	
N		P3		J4	

◆ **請正確使用** Please use it correctly

【共通注意事項】請參閱相關頁。

【Common points for attention】please refer to related pages

■ **關於使用** Concerning the using

(1) 請注意開關的溫度等級，在超過溫度等級的環境條件下使用，將不能保證開關的規定特性。

Please pay attention to the temperature class, if use it beyond the temperature class, switch standard characteristics cannot be guaranteed.

(2) 對於低荷重型開關，由於其構造特殊，請注意不要讓開關跌落，以免損壞內部結構。

About the low operating force switches, please do not drop the switch so as to avoid damage to inside structure, because it is of special structure.

■ **關於安裝** Concerning the installation

(1) 開關的安裝、拆卸和配綫作業以及維護檢查時，請務必斷開電源，否則會引起觸電和燒毀。

Please turn off the power when installing, disassembling, wiring work and maintenance check, otherwise, electric shock and burn will happen.

(2) 安裝時，使用2個M3螺釘，用平墊圈、彈簧墊圈等緊固，並請使用0.4~0.6N·m的緊固轉矩。

When installing, please use 2 M3 screws, then tight it with flat washer, spring washer, and also tight with 0.4~0.6N·m torque.

(3) 開關請安裝在平面上。如果安裝面凹凸不平，可能導致開關歪斜、動作失常和外殼破損。

Please install switch on flat surface. If install it in uneven surface, switch deflection, malfunction and cover breakage will happen.

■ **關於絕緣距離** Concerning insulation distance

根據IEC 61058-1/EN 61058-1/GB 15092.1之規定，本開關的最小絕緣層厚度為1.1mm，端子和安裝板之間的最小空間距離為1.9mm。如果無法確保零部件所要求的絕緣距離，請使用絕緣護罩或隔板來保證絕緣距離。

According to IEC 61058-1/EN 61058-1/GB 15092.1, the least thickness insulation layer should be 1.1mm, the smallest space distance between the terminal and install board is 1.9mm. If the parts insulation distance cannot be guaranteed, please use insulate cover or guard board to guarantee the insulation distance.

■ **關於微小負載電路中的使用** Concerning use in small load circuit

如果在開關微小負載電路中使用一般負載用開關，可能會引起接觸不良。

Use general load switch in small load circuit, bad contact may happen

請參考下圖在使用區域的範圍內使用開關，並根據需要插入觸點保護電路。

Please refer to the chart below, use switch within using region, and insert contact protection circuit according to the needs.

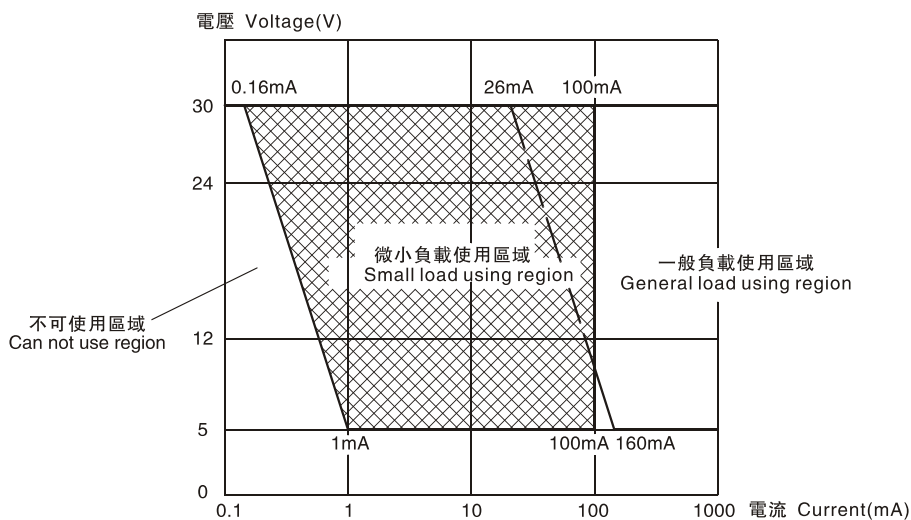

KW3A 微動開關組件 Micro switch groupware

◆ 特點和用途 Characteristic and usage

- 自鎖式或按鈕式，大電流。
Self locked or button type, big current
- 結構緊湊，體積小。
Tight configuration, small volume.
- 可直接用手操動
Can be operated by hand
- 用于特殊場合的電源通斷和電氣控制
Applied to power on/off and electric control in special situations

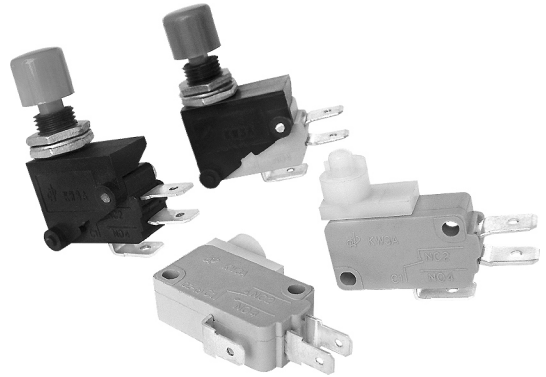

◆ 技術特性 Specifications

項目 Item		特性值 Value	
		按鈕型 Button type	自鎖型 Self lock
溫度等級 Degree of temperature		T105	
額定電壓 Rated voltage		AC250V	
絕緣電阻 Insulation resistance		$\geq 100M\Omega$ (500VDC)	
接觸電阻 Contact resistance		$\leq 30m\Omega$ (初始值 initial value)	
耐電壓 Test voltage	同極不相接端子間 Between terminals of the same polarity	AC1000V, 50/60Hz, 1min	
	帶電金屬零件與地(外殼)之間、接綫端與不帶電金屬件之間 Between current-carrying metal parts and ground(case), and between each terminal and non-current-carrying metal parts.	AC3750V, 50/60Hz, 1min	
電氣壽命 Electrical life		50,000次/cycles	10,000次/cycles
質量 Weight		約15.5 g/approx. 15.5g	約7.9 g/approx. 7.9g



◆ 型號規格命名及含義 Model number legend and meanings

KW3A - □ □ □ □ □
1 2 3 4 5

<p>1 結構型式 Configuration types</p>	<p>A: 按鈕型 Button type B: 自鎖型 Self lock</p>	<p>4 端子類型 Terminal types</p>	<p>A: 250快接端子 250 quick-connect terminal B: 187快接端子(厚0.8mm) 187 quick-connect terminal(thick 0.8mm) C: 187快接端子(厚0.5mm) 187 quick-connect terminal(thick 0.5mm) Y: 非標準端子 Not standard terminal</p>
<p>2 額定值 Ratings</p>	<p>16: 16(4)A 250V AC 10: 10(3)A 250V AC</p>	<p>5 按鈕顏色 Button color</p>	<p>R:紅色 Red G:綠色 Green B:藍色 Blue (僅適用於按鈕型 Only used in Button type)</p>
<p>3 接觸形式 Circuit</p>	<p>Z: 轉換式 SPDT T: 常開(按通)式 SPST-NO D: 常閉(按斷)式 SPST-NC</p>		

◆ 外形和安裝尺寸 Outline and mounting dimensions

KW3A-A□ZA□

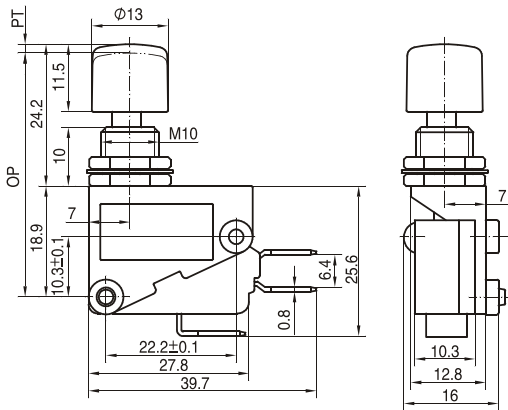

OF (N)	1.50-2.00
RF Min (N)	0.40
PT Max (mm)	1.2
OT Min (mm)	1.0
MD Max (mm)	0.4
OP (mm)	42 ± 0.5

KW3A-B□ZC

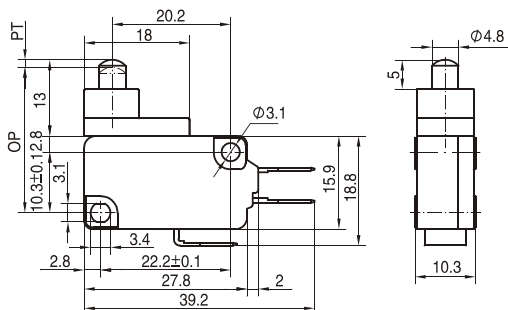

Total travel

OF (N)	2.00-3.00
RF min(N)	0.40
PT (mm)	1.3
TT (mm)	3.2

KW3A 微動開關組件貳 Micro switch groupware

◆ 特點和用途 Characteristic and usage

- 防傾倒式，大電流。
Safety type, big current
- 可利用開關方向和位置的變化，實現電源通斷的自動切換。
Using the change of switch direction and position then automatically control the power on or off.

◆ 技術特性型號規格命名及含義 Model specs naming and meanings

KW3A- □ □ □ □ - □ □ □ □ - (□)
1 2 3 6 7 8 9 10 11

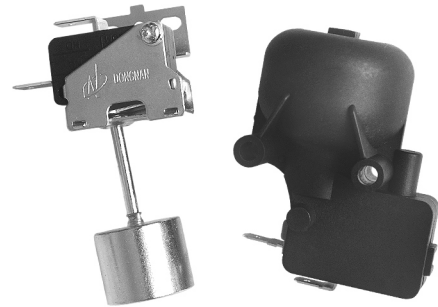

1	2	3	6-11
結構型式 Configuration types	額定值 Ratings	接觸形式 Circuit	
C-防傾倒式 I Safety type I D-防傾倒式 II Safety type II	16: 16(4)A 250V AC 10: 10A 250V AC	Z: 轉換式 SPDT T: 常開(按通)式 SPST-NO D: 常閉(按斷)式 SPST-NC	含義同KW3A基本型相應編號6-11,見本目錄第8頁。 Same meaning with KW3A basic part number naming (6-11), see catalogue page 8.

◆ 技術特性 Specifications

項目 Item	特性值 Value	
	C型 C type	D型 D type
溫度等級 Degree of temperature	10T105	
額定電壓 Rated voltage	AC250V	
絕緣電阻 Insulation resistance	≥ 100MΩ (500VDC)	
接觸電阻 Contact resistance	≤ 30mΩ (初始值 initial value)	
耐電壓 Test voltage	同極不相接端子間 Between not connect terminals of the same polarity	
	帶電金屬零件與地(外殼)之間、接綫端與不帶電金屬件之間 Between current-carrying metal parts and ground(case), and between each terminal and non-current-carrying metal parts.	
電氣壽命 Electrical life	50,000次/cycles	
質量 Weight	約57 g/approx. 57g	約58 g/approx. 58g

◆ 外形和安裝尺寸 Appearance and mouting dimentions

KW3A-C□DB-A120A	KW3A-D□DB-A100B
